



201 N. Champaign St. Bement, Illinois 61813

## COMPRESSOR REPLACEMENT B9=75

**Media Type:** Microglass

Max Working Pressure (psi): 175

Core Collapse Pressure (psid): 80

$\beta_4=6$   
 $\beta_6=19$   
 $\beta_9=75$   
 $\beta_{12}=200$   
 $\beta_{14}=500$

### NOTES:

1. Technical Data subject to change without notice.
2. Tests are conducted with Mobile Aero HFA Aviation Hydraulic Fluid.
3. Filters are not to be used with aviation applications.

jw 02/25/09 Rev A

## Technical Data Sheet - 70323

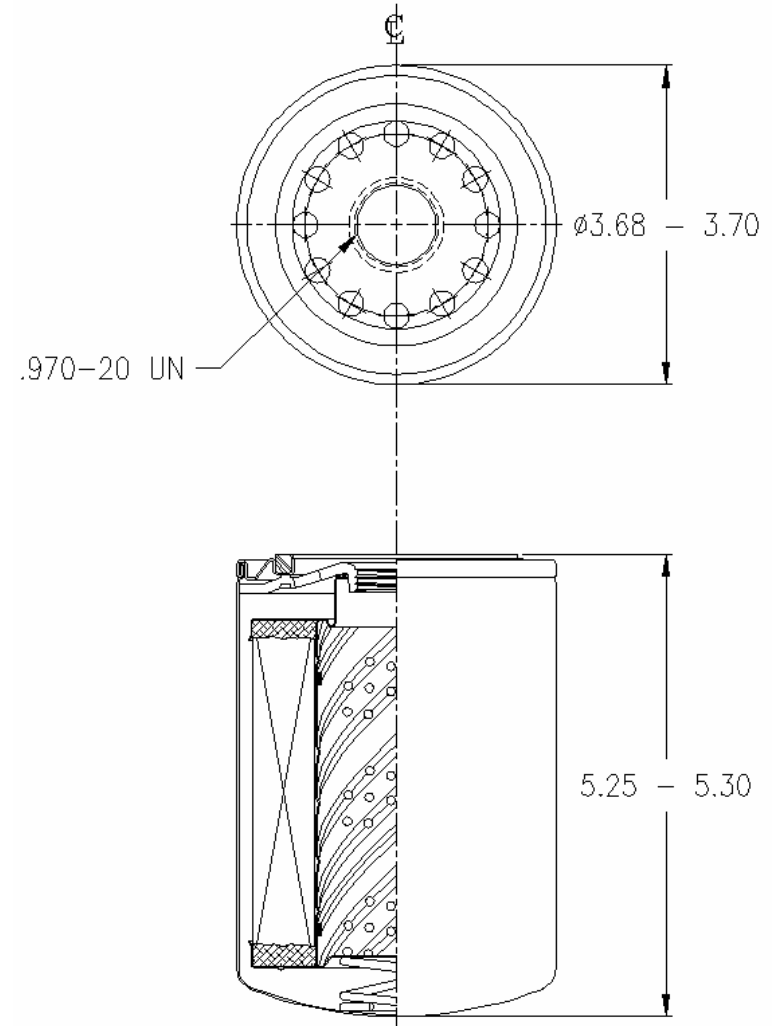

Gasket:

I. D. 2 13/32

O. D. 2 25/32