



201 N. Champaign St. Bement, Illinois 61813

260BMG-02 260 SERIES 2 MICRON BIO-TEK

Media Type: Microglass

Max Working Pressure (psi): 50

Core Collapse Pressure (psid): 80

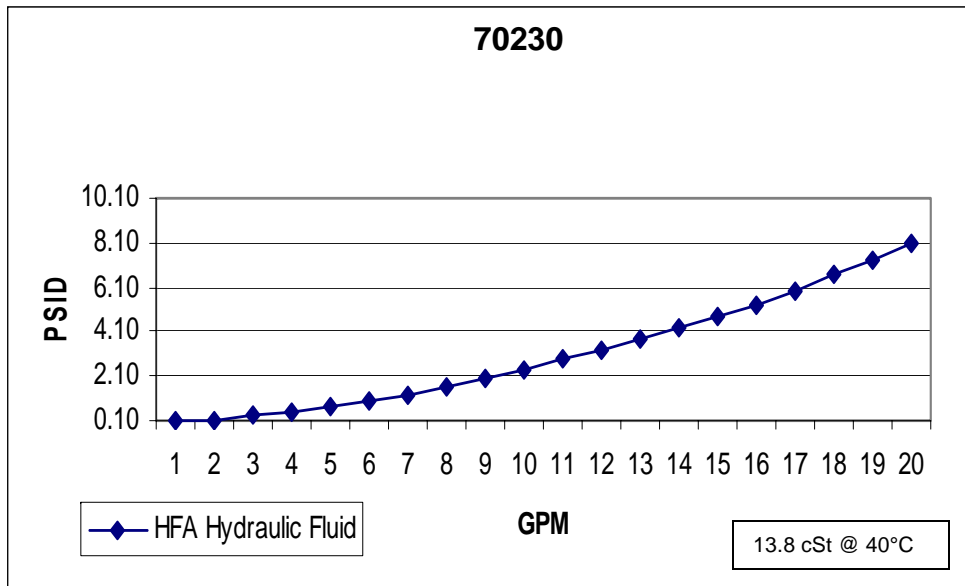

NOTES:

1. Technical Data subject to change without notice.
2. Tests are conducted with Mobile Aero HFA Aviation Hydraulic Fluid.
3. Filters are not to be used with aviation applications.

jw 02/20/09 Rev A

Technical Data Sheet -70230

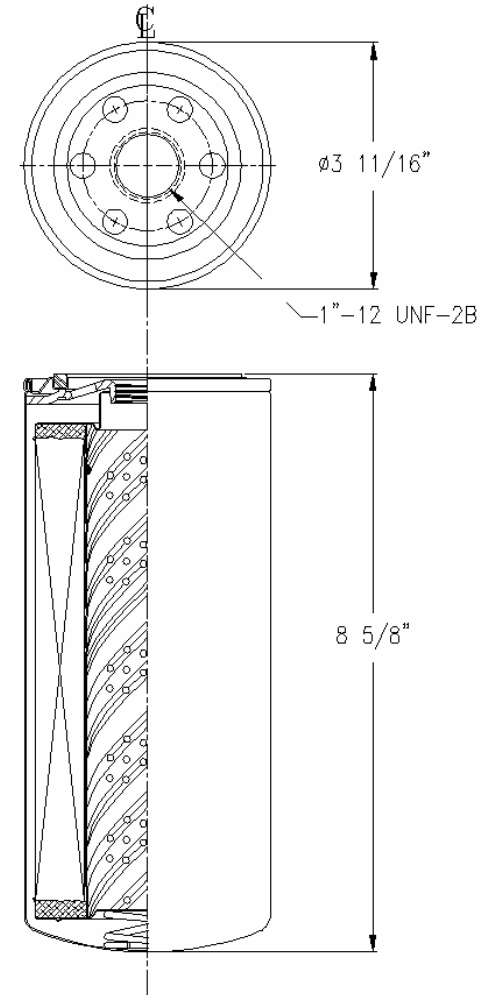

Gasket:

I. D. 2 13/32

O. D. 2 25/32