



201 N. Champaign St. Bement, Illinois 61813

800-10 800 SERIES 10 MICRON

Media Type: Cellulose

Max Working Pressure (psi): 50

Core Collapse Pressure (psid): 80

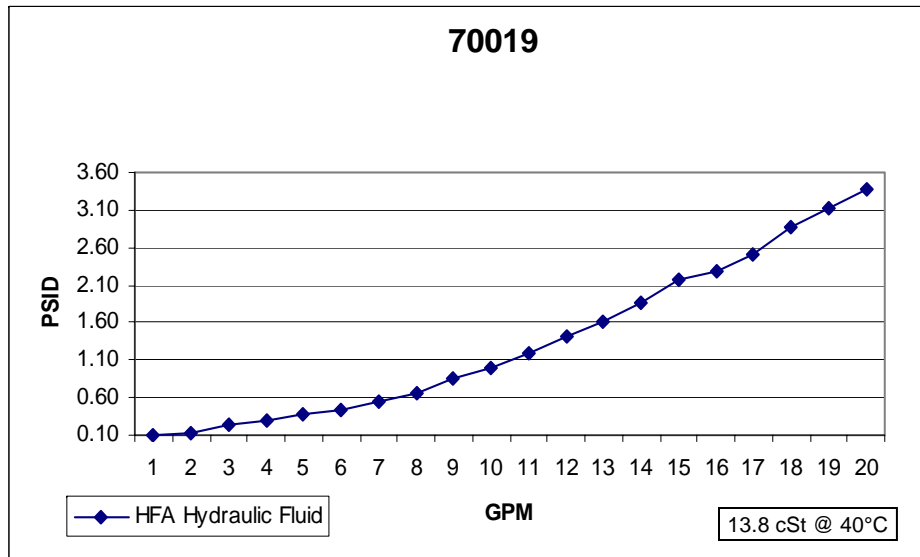

NOTES:

1. Technical Data subject to change without notice.
2. Tests are conducted with Mobile Aero HFA Aviation Hydraulic Fluid.
3. Filters are not to be used with aviation applications.

jw 02/17/09 Rev A

Technical Data Sheet - 70019

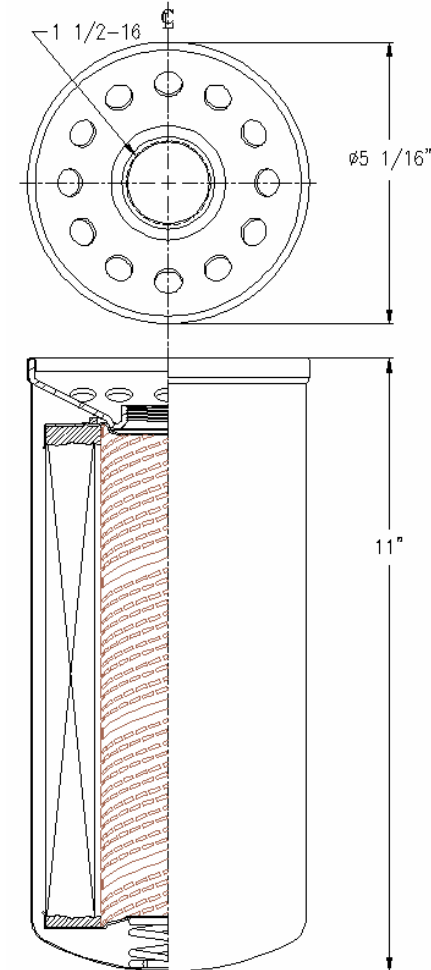

Gasket:

I. D. 4 23/32

O. D. 5 1/16